

ARTICOLI NUOVI
DISPONIBILI A MAGAZZINO



FLASH NEWS

MAGGIO 2026

PDF interattivo:
Fai clic sulla foto per visualizzare l'articolo in dettaglio



130155

Tubi ,raccordi acq

POSIZIONE
Assale Anteriore, Inf.



APPLICAZIONI
AUDI A4 (8K_) -ALLROAD (8KH)
07- A5 (8_ ,8F7) 07- Q5 (8RB) 08-

ADATTABILI ad O.E.
06E 121 045 AB / 06E 121 045 J

130156

Tubi ,raccordi acq

POSIZIONE
Assale Anteriore, Inf.



APPLICAZIONI
AUDI A4 (8K_) -ALLROAD (8KH)
07- A5 (8_ ,8F7) 07- Q7 (4LB) 06-

ADATTABILI ad O.E.
06E 121 045 BA / 06E121045AE

130157

Tubi ,raccordi acq

POSIZIONE
Assale Anteriore, Inf.



APPLICAZIONI
AUDI A4 (8K_) -ALLROAD (8KH)
07- A5 (8_ ,8F7) 07- A6 (4F2, 4F5)
- ALLROAD (4FH) 04-

ADATTABILI ad O.E.
03L 121 065 K

160081

Tubi ,raccordi acq

POSIZIONE
Assale Anteriore



APPLICAZIONI
AUDI A1 (8X1, 8XA, 8XF, 8XK)
10- A3 (8P1, 8PA, 8P7) 08-; SEAT
ALHAMBRA (710, 711) 10-

ADATTABILI ad O.E.
04E121070AD / 04E121070L

160203

Vaschette acqua con tappo

POSIZIONE
Assale Anteriore, Sup.



APPLICAZIONI
PORSCHE 911 (996, 997), BOX-
STER (986, 987), CAYMAN (987)
04-

ADATTABILI ad O.E.
99610614708

187134

Boccole ponte

POSIZIONE
Assale Post, Bilaterale



APPLICAZIONI
CITROEN JUMPY 07-11; FIAT SCU-
DO (270_) 07-; PEUGEOT EXPERT
(VF3A_, VF3U_, VF3X_, VF3V_) 07-

ADATTABILI ad O.E.
1400171280 / 5131.F4

190127

Mozzi ruota

POSIZIONE
Assale Anteriore



APPLICAZIONI
KIA SOUL (AM) 09- SOUL II (PS)
14-

ADATTABILI ad O.E.
517502K000

190128

Mozzi ruota

POSIZIONE
Assale Posteriore



APPLICAZIONI
LEXUS TUTTI I MODELLI / ALL
MODELS 14-; TOYOTA RAV 4 III
(ACA_, ACE_, ALA_, GSA3_) 05-

ADATTABILI ad O.E.
4241042040 / 424100R010

190129

Mozzi ruota

POSIZIONE
Assale Anteriore



APPLICAZIONI
TOYOTA C-HR (_X1_) 16- CO-
ROLLA (_E21_) 18- YARIS CROSS
(MXP_) 20-

ADATTABILI ad O.E.
43550F4010

190130

Mozzi ruota

POSIZIONE
Assale Posteriore



APPLICAZIONI
MCD CLASSE A (W169), CLASSE
B (W245) 04-

ADATTABILI ad O.E.
A1699810027 / 1699810027

190131

Mozzi ruota

POSIZIONE
Assale Post, Bilaterale

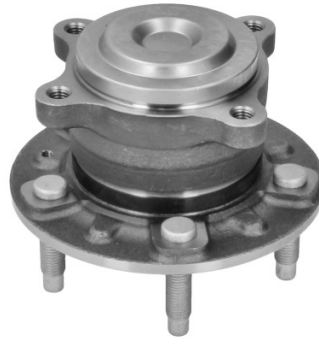

APPLICAZIONI
CHEVROLET CRUZE (J300-
J305-J308) 09-; OPEL AMPERA
(R12) 11-; OPEL ASTRA J - GTC

ADATTABILI ad O.E.
13577407 / 13591999 / 328037

190132

Mozzi ruota

POSIZIONE
Assale Anteriore



APPLICAZIONI
NISSAN X-TRAIL (T32) 13-

ADATTABILI ad O.E.
402024CM0A / 402026FK0A

190133

Mozzi ruota

POSIZIONE
Assale Posteriore



APPLICAZIONI
SUBARU FORESTER (SF, SG, SH)
08- IMPREZA I/II/III (G_) 08- IM-
PREZA V (GT_, GK_) 16-

ADATTABILI ad O.E.
28473FG000 / 28473AJ00A

190143

Mozzi ruota

POSIZIONE
Assale Posteriore



APPLICAZIONI
PEUGEOT 407 (6C_, 6D_, 6E_) 05-
RCZ 10-

ADATTABILI ad O.E.
3748.89

190144

Mozzi ruota

POSIZIONE
Assale Post, Bilaterale



APPLICAZIONI
TOYOTA PRIUS I/II (NHW11_,
NHW20_) 00-04

ADATTABILI ad O.E.
4245047020

295092

Tiranti, supp. cambio

POSIZIONE
Assale Anteriore, Inf.



APPLICAZIONI
CITROEN EVASION (22, U6_, AF_)
94-02 JUMPY (BS/T/U/V/W/X/
Y/Z_, U6U) 94-99

ADATTABILI ad O.E.
2452.70 / 2452.71

301032

Tappi rabbocco olio

POSIZIONE
Assale Anteriore, Sup.



APPLICAZIONI
ALFA ROMEO MITO (955) 08-;FIAT
500 (312) 07-;FIAT 500 X 14-;FIAT
500L 14-;FIAT IDEA (350_) 03-

ADATTABILI ad O.E.
55256373 / 55256372

309039

Tappi coppa olio

POSIZIONE
Assale Anteriore, Inf.



APPLICAZIONI
SMART CITY, COUPÉ, CABRIO,
CROSSBLADE, ROADSTER (450)
98-

ADATTABILI ad O.E.
A160 014 0002 / 160 014 0002 /
Q000 3015 V004 / 000 3015 V004

314013

Carter riparicinghia

POSIZIONE
Assale Anteriore

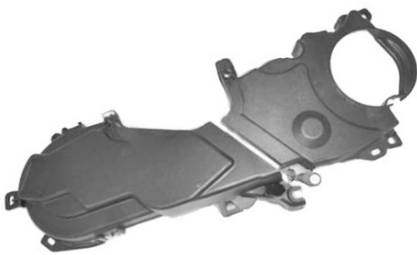

APPLICAZIONI
FORD C-MAX 03-07 C-MAX (DM2)
07- FOCUS II (DA_, DAW_) 04- GA-
LAXY (WA6) 06- KUGA 08-

ADATTABILI ad O.E.
9682068380 / 9642549980 /
1474381 / 1340737

314016

Carter riparicinghia

POSIZIONE
Assale Anteriore



APPLICAZIONI
CITROEN C4 (B7, NC_) 09- C4
PICASSO I, GRAND PICASSO I
(UA_, UD_) 07- JUMPY 07-11

ADATTABILI ad O.E.
0320.AG / 0320.AF / 1683832 /
1683826

340210

Radiatori olio

POSIZIONE
Assale Anteriore

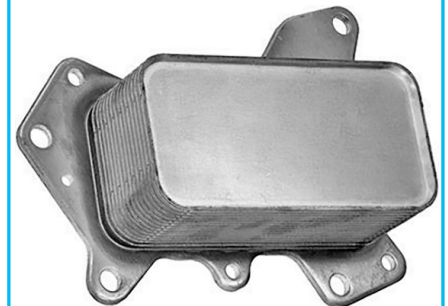

APPLICAZIONI
MCD CLASSE E (W214) 23- CLAS-
SE E ALL-TERRAIN (S214) 23-
CLASSE E T-MODEL (S214) 23-

ADATTABILI ad O.E.
A2561801500 / 2561801500

340211

Radiatore olio cambio automatico

POSIZIONE
Assale Anteriore



APPLICAZIONI
SUBARU IMPREZA HATCHBACK (GU_) 23- IMPREZA I/II/III (G_) 00- IMPREZA IV (GP) 12-

ADATTABILI ad O.E.
31237AA000

340212

Radiatori olio

POSIZIONE
Assale Anteriore

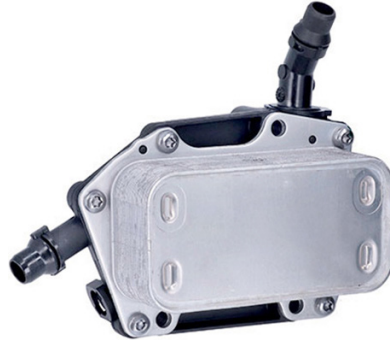

APPLICAZIONI
BMW SERIE 2 (F22, F23, F44, F45, F46) 14- X1 (F48) 15- X2 (F39) 17-

ADATTABILI ad O.E.
17217640013

340213

Radiatori olio

POSIZIONE
Assale Anteriore

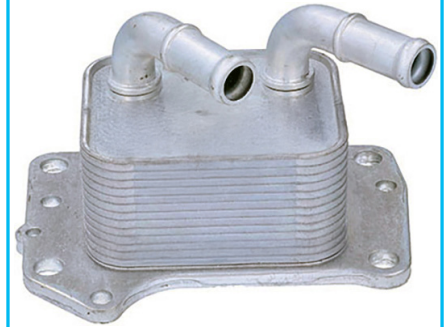

APPLICAZIONI
HYUNDAI SANTA FÉ IV (TM) 18- ; KIA SORENTO IV (MQ4) 20-

ADATTABILI ad O.E.
26410-2S000 / 26410-2S010

340214

Radiatori olio

POSIZIONE
Assale Anteriore

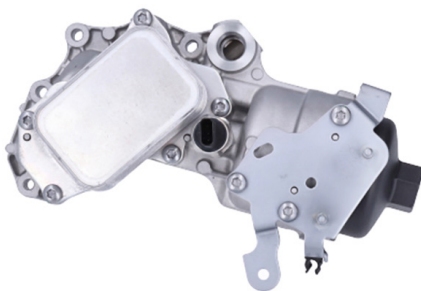

APPLICAZIONI
CITROEN BERLINGO (K9) 18- C-ELYSEE 12- C3 AIRCROSS II (2R_2C_) 17- C4 III (B_) 20-

ADATTABILI ad O.E.
9823532380 / 3553743 / 2191041 / 2192709

340215

Radiatore olio cambio automatico

POSIZIONE
Assale Anteriore



APPLICAZIONI
VW CALIFORNIA T5 CAMPER (7EC, 7EF, 7EG, 7HF) 07- MULTI-VAN VI (SG_) 15-

ADATTABILI ad O.E.
OBT317019

340216

Radiatori olio

POSIZIONE
Assale Anteriore

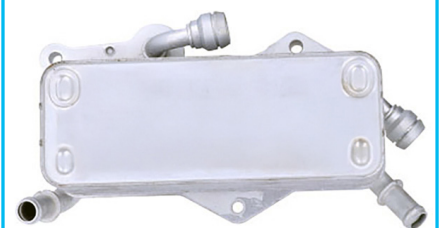

APPLICAZIONI
AUDI A6 (4G2, 4G5, 4GC, C7) - A6 ALLROAD (4GH) 11- A7 (4GA, 4GF) 10-

ADATTABILI ad O.E.
4G0317021AG / 4G0317021M

340218

Radiatori olio

POSIZIONE
Assale Anteriore

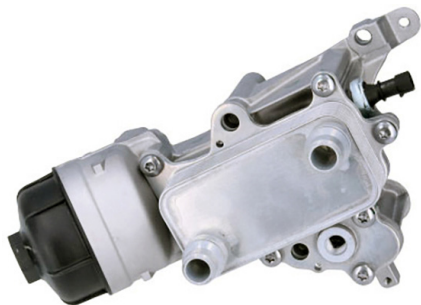

APPLICAZIONI
ALFA ROMEO GIULIETTA (940) 10-
;FIAT 500 X 14-;FIAT 500L 14-;FIAT
BRAVO II (198) 06-

ADATTABILI ad O.E.
46337144 / 46337146

340219

Intercooler

POSIZIONE
Assale Anteriore

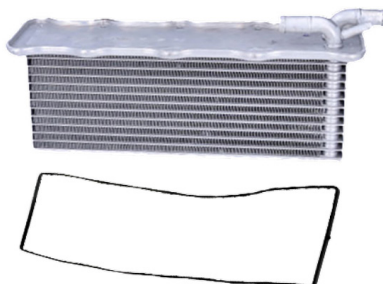

APPLICAZIONI
AUDI A1 (8X1, 8XA, 8XF, 8XK)
10- A3 (8VA, 8VS, 8V7, 8VK, 8VF,
8VM) 13- Q3 (8UB) 11-

ADATTABILI ad O.E.
04E145749B / 04E145749F

340220

Radiatore olio cambio
automatico

POSIZIONE
Assale Anteriore

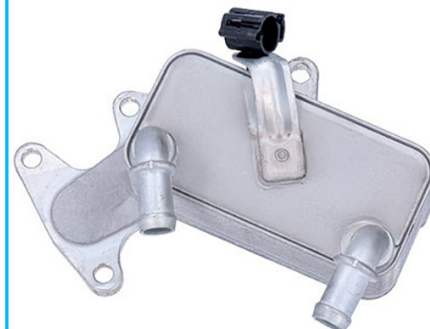

APPLICAZIONI
VW JETTA IV (162) 10-

ADATTABILI ad O.E.
09G409061E

340221

Radiatore olio cambio
automatico

POSIZIONE
Assale Anteriore

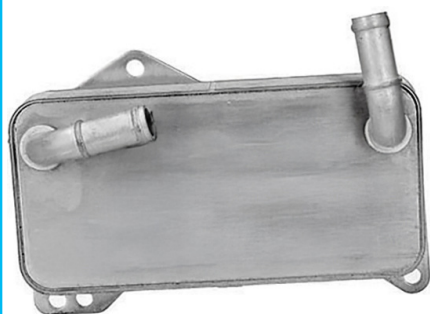

APPLICAZIONI
VW TIGUAN (5N_) 07-

ADATTABILI ad O.E.
0BH317019C

340222

Radiatori olio

POSIZIONE
Assale Anteriore



APPLICAZIONI
AUDI A4 (8H7, 8HE, 8EC, 8ED) 02-
A4 (8K_) -ALLROAD (8KH) 07- A4
(8W2, 8W5, B9) 15-

ADATTABILI ad O.E.
05L117021B

340223

Radiatori olio

POSIZIONE
Assale Anteriore



APPLICAZIONI
AUDI A3 (8P1, 8PA, 8P7) 03- A3
(8VA, 8VS, 8V7, 8VK, 8VF, 8VM)
13- A3 (8YA, 8YS) 20-

ADATTABILI ad O.E.
05L117021C

340224

Radiatori olio

POSIZIONE
Assale Anteriore

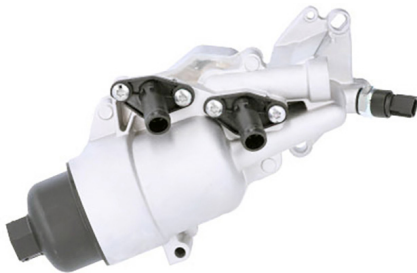

APPLICAZIONI
RENAULT MASTER II (JD/ND, FD,
ED/HD/UD) 98- MASTER III (JD,
HD, FD, ED, UD) 03-

ADATTABILI ad O.E.
820058995 / 8200589951

340225

Radiatore olio cambio
automatico

POSIZIONE
Assale Anteriore



APPLICAZIONI
BMW SERIE 3 (E90, E91, E92, E93)
05- SERIE 5 (F07, F10, F11) 10- X5
(E70) 07-

ADATTABILI ad O.E.
17217800408

340226

Radiatori olio

POSIZIONE
Assale Anteriore

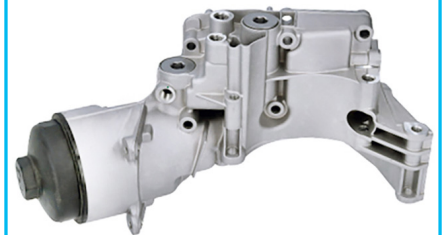

APPLICAZIONI
BMW SERIE 3 (E46) 98- SERIE 5
(E39) - Z8 (E52) 95-04 SERIE 5
(E60, E61) 03-

ADATTABILI ad O.E.
11421713838

340227

Radiatori olio

POSIZIONE
Assale Anteriore



APPLICAZIONI
DACIA LOGAN II, MCV 12- SAN-
DERO II 12-;RENAULT CLIO II
(SB0/1/2_, BB0/1/2_, CB0/1/2_)

ADATTABILI ad O.E.
8200537406 / 8200780410

340230

Radiatore olio cambio
automatico

POSIZIONE
Assale Anteriore



APPLICAZIONI
AUDI A4 (8W2, 8W5, B9) 15- A5
(F53, F5A, F57) 16- Q5 (FYB, FYG)
16-

ADATTABILI ad O.E.
03N1153895

340231

Radiatori olio

POSIZIONE
Assale Anteriore



APPLICAZIONI
AUDI A6 (4G2, 4G5, 4GC, C7) - A6
ALLROAD (4GH) 11- Q5 (8RB) 08-

ADATTABILI ad O.E.
03N115389R

340232

Radiatori olio

POSIZIONE
Assale Anteriore



APPLICAZIONI
MINI (R56), MINI CLUBMAN/
CLUBVAN (R55) 06- MINI CABRIO-
LET (R52, R57) 07-

ADATTABILI ad O.E.
11428507150 / 15670WA010 /
8507150

340233

Radiatori olio

POSIZIONE
Assale Anteriore



APPLICAZIONI
AUDI A4 (8K_) -ALLROAD (8KH)
07- A5 (8_ ,8F7) 07- Q5 (8RB) 08-

ADATTABILI ad O.E.
03N115389H

370555

Supporti ammortizzatori

POSIZIONE
Assale Ant, Bilaterale



APPLICAZIONI
NISSAN NAVARA (D23) 14- NAVA-
RA (D40) 04-;RENAULT ALASKAN
17-

ADATTABILI ad O.E.
56115EB70A / 54034EB70A

380019

Tamponi ammortizzatore

POSIZIONE
Assale Ant, Bilaterale



APPLICAZIONI
SAAB 9-5 (YS3E) 97-

ADATTABILI ad O.E.
52 32 863

380135

Tamponi ammortizzatore

POSIZIONE
Assale Post, Bilaterale



APPLICAZIONI
FORD MONDEO III (B4Y, B5Y,
BWY) 00-07

ADATTABILI ad O.E.
1S715K570BA / 1 123 580

380625

Tamponi ammortizzatore

POSIZIONE
Assale Ant, Bilaterale



APPLICAZIONI
CITROEN BERLINGO (K9) 18- JU-
MPY 16- SPACETOURER 16-;FIAT
SCUDO AUTOBUS 22-

ADATTABILI ad O.E.
9810806480 / 9820366380

430859

Supporti e tiranti motore

POSIZIONE
Assale Anteriore

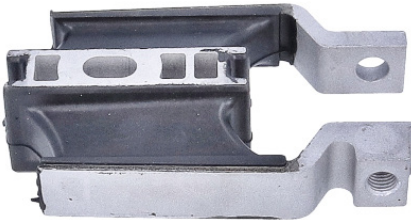

APPLICAZIONI
POLESTAR POLESTAR 1 (P)
18-;VOLVO S90 II - V90 II 16-;VOL-
VO XC 60 II 17-

ADATTABILI ad O.E.
31330594

450079

Supporti cambio

POSIZIONE
Assale Anteriore, lato sx



APPLICAZIONI
AUDI A4 (8D2, 8D5, B5) 95-01
A4 (8E2, 8E5, B6) 00-04 A4 (8H7,
8HE, 8EC, 8ED) 02-

ADATTABILI ad O.E.
8D0399415F / 8D0 399 415E

460568

Flange Manicotto, portabulbo

POSIZIONE
Assale Anteriore



APPLICAZIONI
ALFA ROMEO GIULIETTA (940) 10-
MITO (955) 08-;FIAT 500L 14-;FIAT
BRAVO II (198) 06-

ADATTABILI ad O.E.
55207564

460570

Flange Manicotto, portabulbo

POSIZIONE
Assale Anteriore, Inf.



APPLICAZIONI
HYUNDAI ACCENT V (HC) 17-
ELANTRA (AD) 16-;KIA CEE'D
(CD), PRO CEE'D (CD) 18-

ADATTABILI ad O.E.
256002M000 / 25600-2M002

460571

Flange Manicotto, portabulbo

POSIZIONE
Assale Anteriore, Inf.



APPLICAZIONI
HYUNDAI SANTA FÉ III / GRAND
SANTA FÉ (DM) 13- SANTA FÉ IV
(TM) 18-

ADATTABILI ad O.E.
256302W500 / 25630-1U500

460572

Flange Manicotto, portabulbo

POSIZIONE
Assale Anteriore, Inf.



APPLICAZIONI
LANDROVER DEFENDER (L663)
19- RANGE ROVER IV (LG) 12-
RANGE ROVER SPORT (LW) 13-

ADATTABILI ad O.E.
LR180316 / LR121420

460573

Flange Manicotto, portabulbo

POSIZIONE
Assale Anteriore, Inf.



APPLICAZIONI
ALFA ROMEO GIULIA (952_) 15-
STELVIO (949_) 16-

ADATTABILI ad O.E.
46338166 / 46338164

460574

Flange Manicotto, portabulbo

POSIZIONE
Assale Anteriore, Sup.

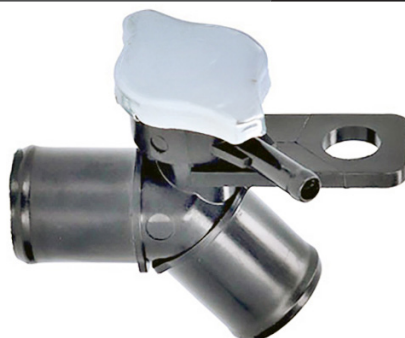

APPLICAZIONI
SUZUKI GRAND VITARA (JT) 05-

ADATTABILI ad O.E.
17910-65J00

460575

Flange Manicotto, portabulbo

POSIZIONE
Assale Anteriore, Inf.



APPLICAZIONI
AUDI A4 (8K_) -ALLROAD (8KH)
07- A5 (8_, 8F7) 07- A7 (4GA, 4GF)
10- A8 (4H_) 09-

ADATTABILI ad O.E.
059121737AK / 059121737G